



SPIRIT FITNESS

A Heritage of Quality | The Spirit of Innovation

Инструкция по сборке гиперэкстензии наклонной



Руководство пользователя



A Heritage of Quality | The Spirit of Innovation
SPIRIT
FITNESS





A Heritage of Quality | The Spirit of Innovation
SPIRIT
FITNESS





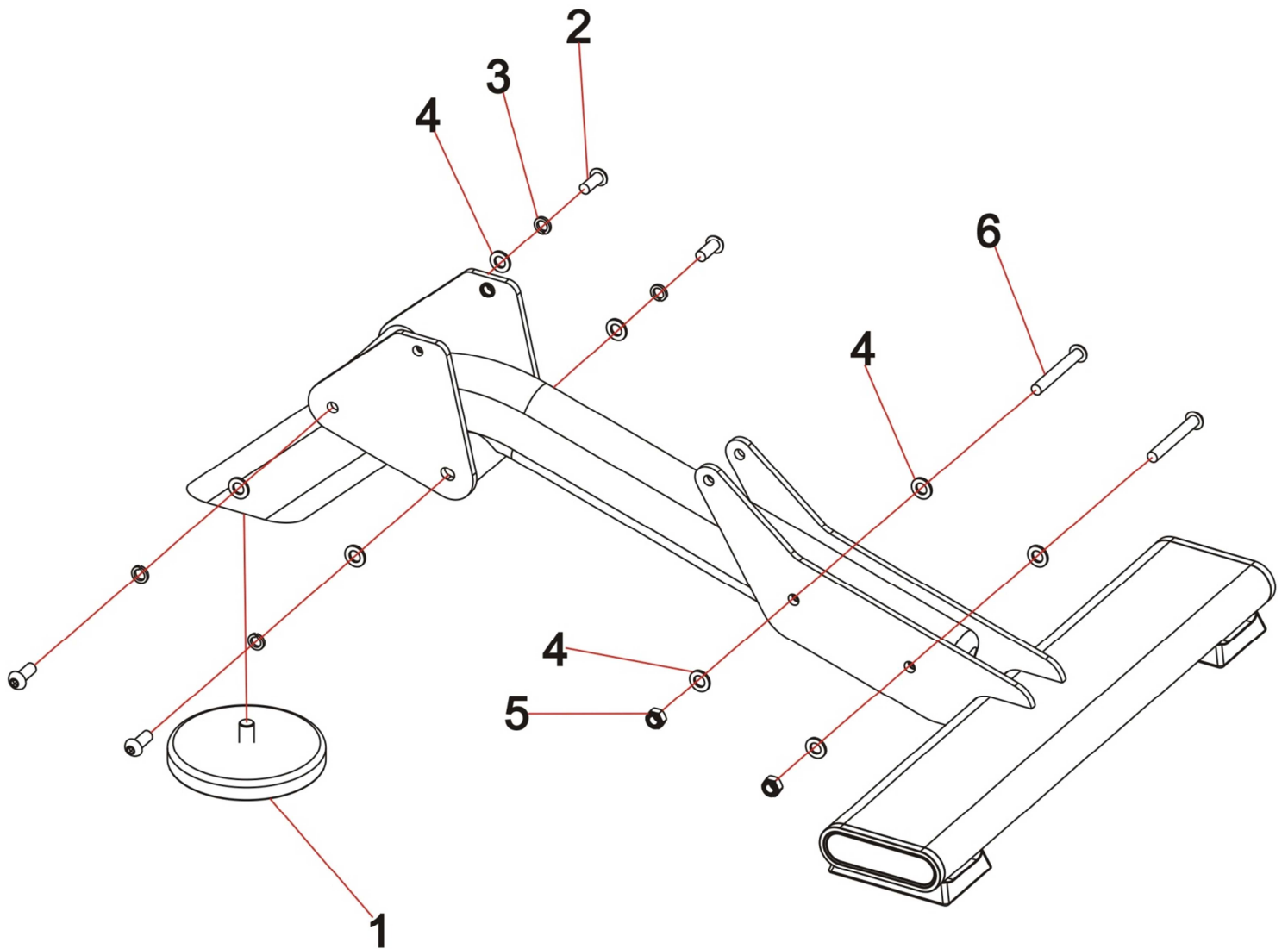

A Heritage of Quality | The Spirit of Innovation
SPIRIT
FITNESS



1





1  X1
 $\Phi 170 \times 20$

2  X4
M12X30 

3  X4
M12 

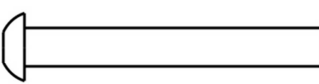

4  X8
M12 



5  X2
M12 

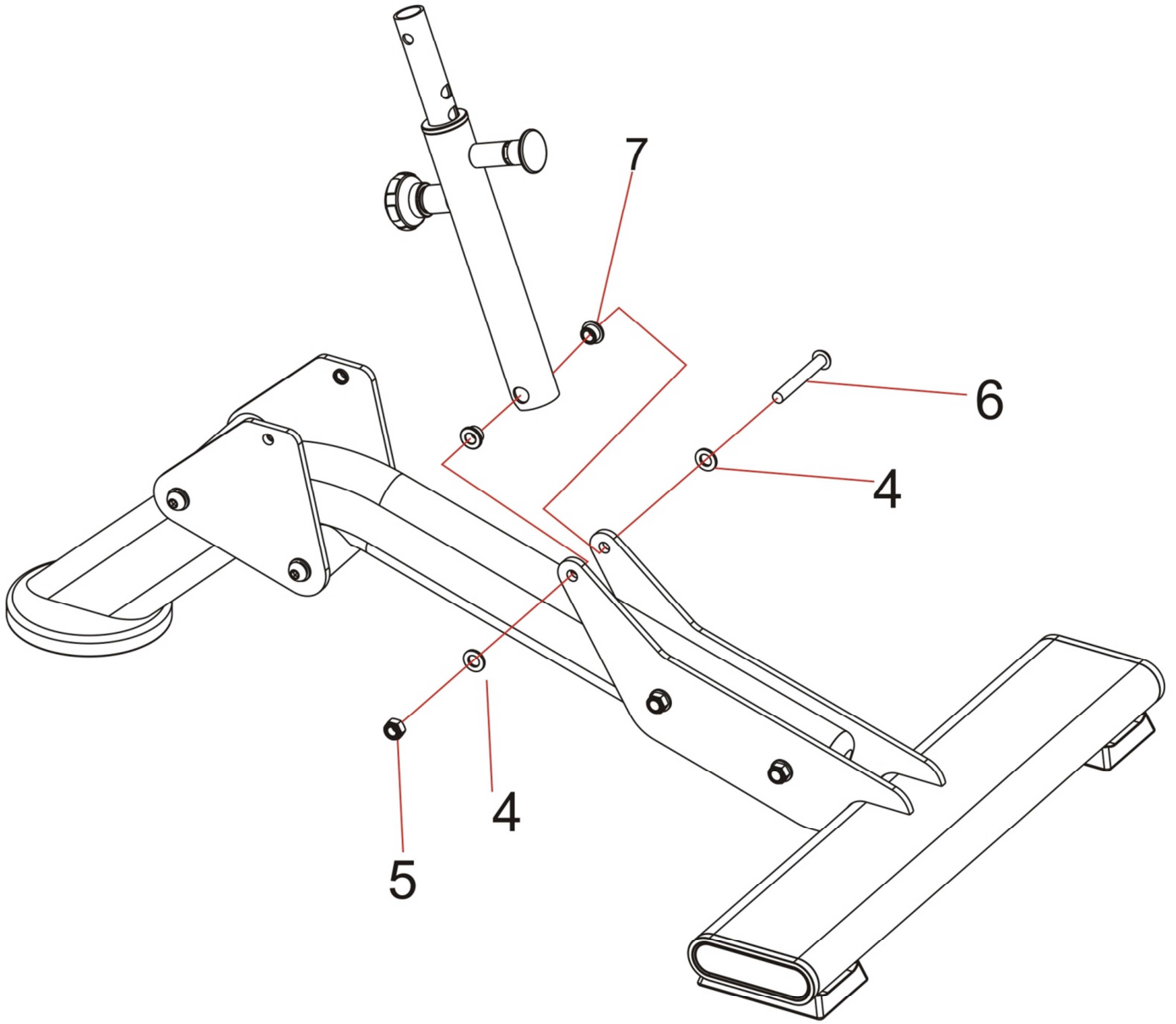

6  X2
M12x90 

2

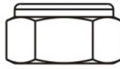

4  X2
M12 

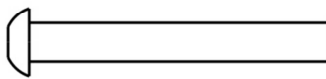

5  X1
M12 



6  X1
M12x90 

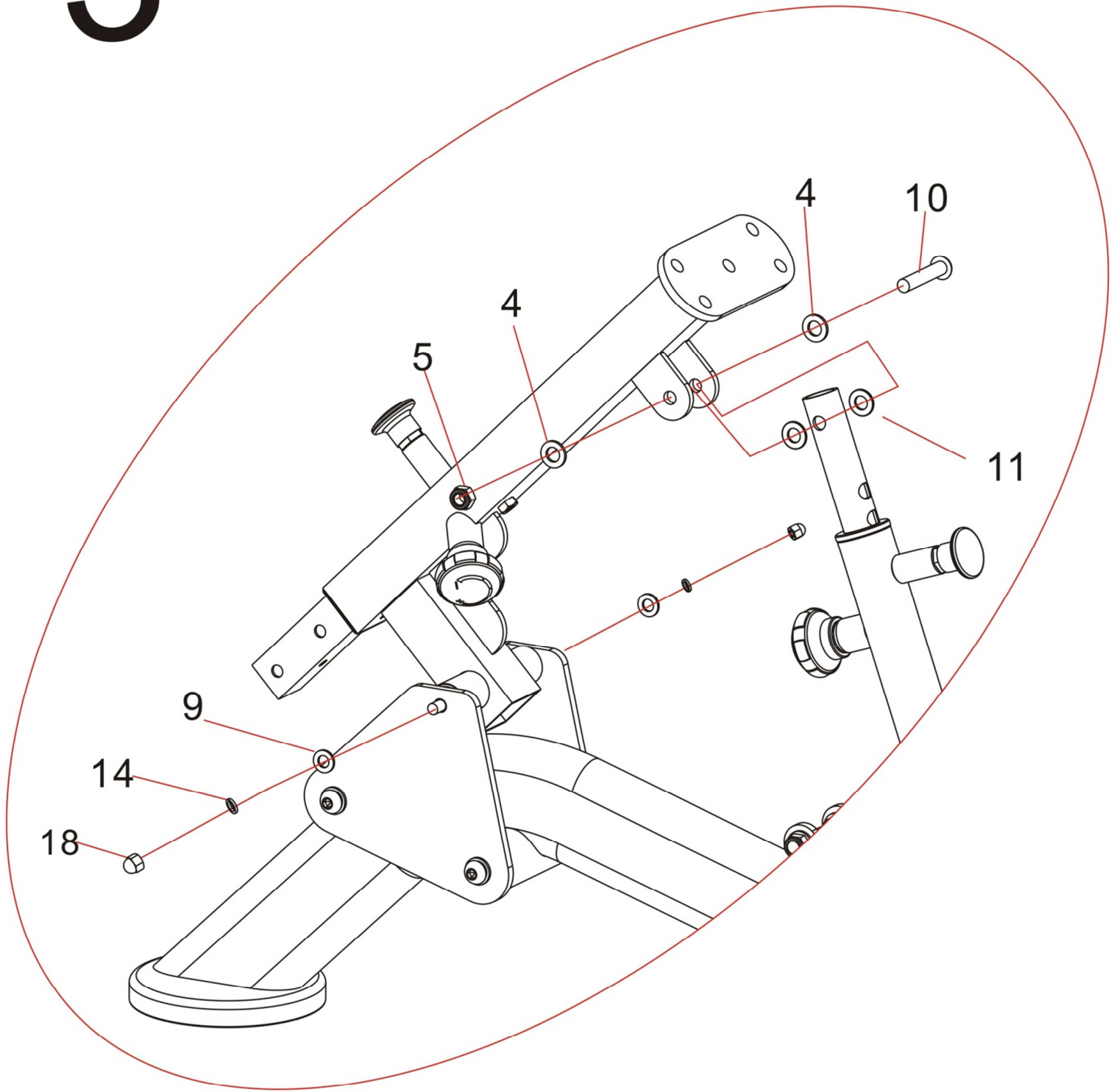

7  X2
 $\Phi 24 * \Phi 12 * 12$

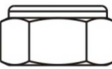

3



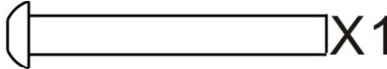

4  X2
M12 



5  X2
M12 

10  X1
M12x65 

14  X2
M10 

9  X2
M10 

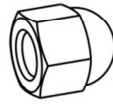
11  X2
M12X2





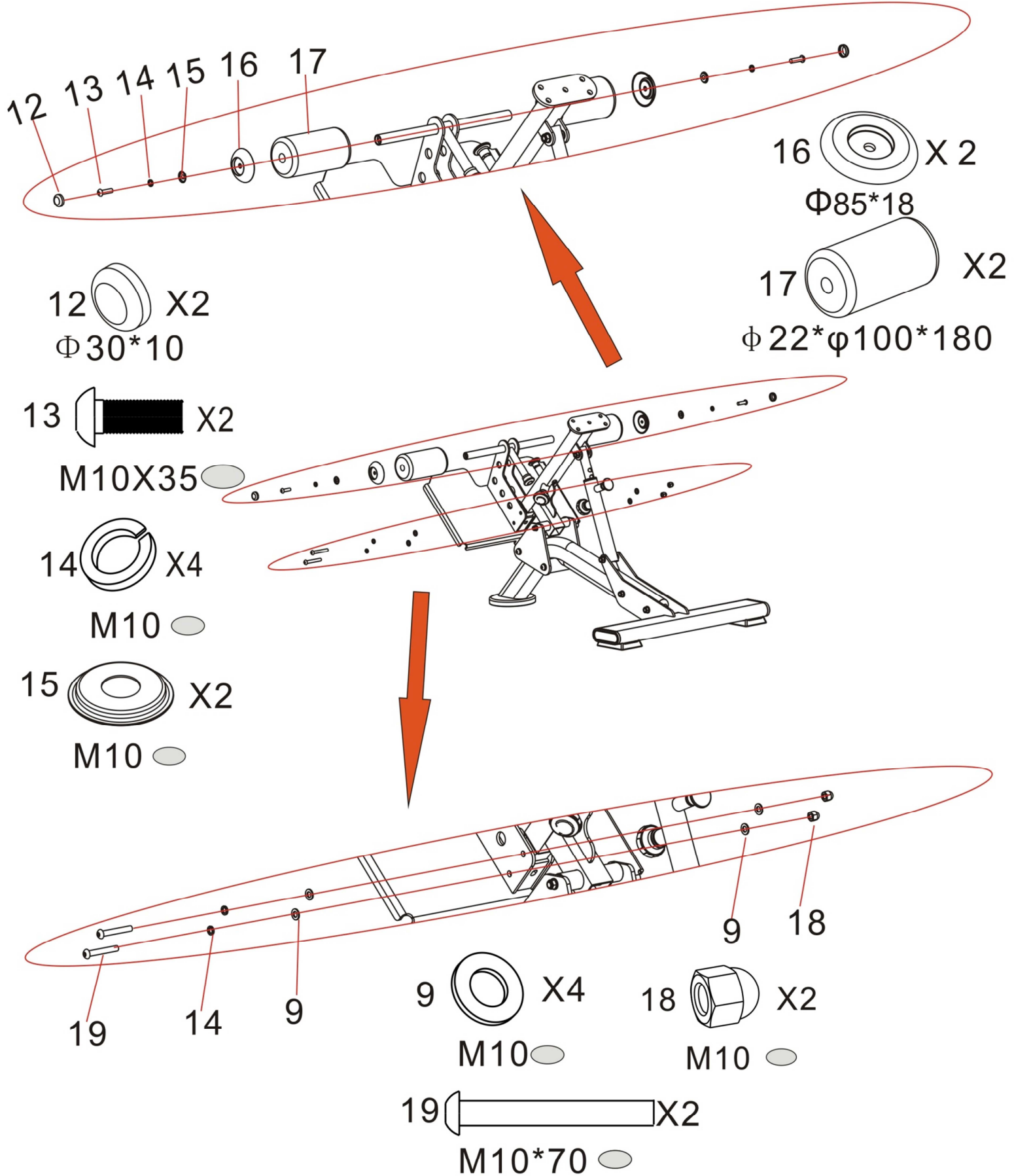

18  X4
M10 

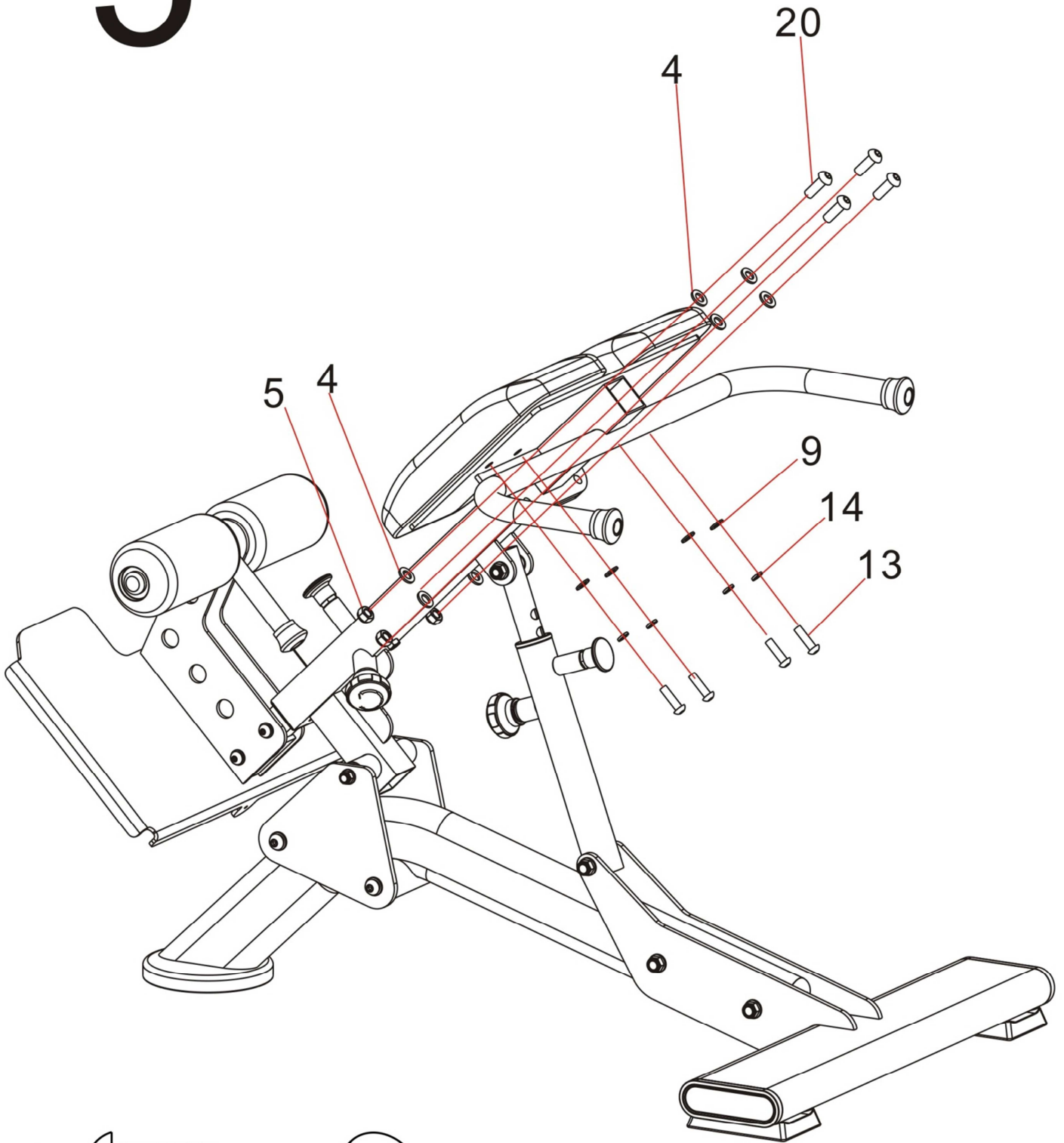
4





5



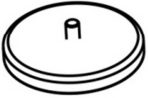

- 8  X4 4  X8 5  X4
M12X35  M12  M12 

- 13  X4 14  X4 9  X4
M10X35  M10  M10 



1  X1
Φ 170X20

2  X4
M12X30 



3  X4
M12 

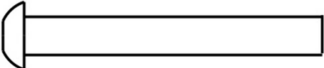

4  X20
M12 

5  X9
M12 

6  X3
M12x90 

7  X2
Φ 24*Φ 12*12



8  X4
M12X35 



9  X10
M10 

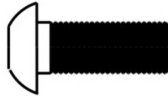

10  X1
M12x65 

11  X2
M12X2

12  X2
Φ 30*10

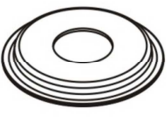

13  X6
M10X35 

14  X10
M10 

15  X2
M10 

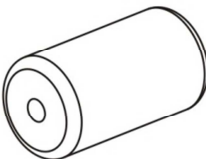
16  X 2
Φ 85*18

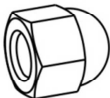
17  X2
Φ 22*φ 100*180

18  X4
M10 

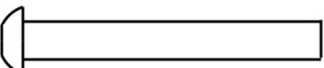
19  X2
M10*70 