



## COMMERCIAL SELECTORIZED PRODUCTS

Singles ♦ Duals ♦ Functional ♦ Modular Multi-Stations

## SINGLE EXERCISE STATIONS

### HS/HSG Series

Manufactured to the same high standards as their dual-function counterpart, the HOIST® HS single stations are designed to be the perfect accompaniment to our HD line.

## DUAL • MULTI • FUNCTIONAL EXERCISE STATIONS

### HD/HDG Series

The expanded HOIST® HD series offers a comprehensive solution for fitness facilities where space, budget or both are at a premium. A properly designed HD circuit can fit 10 to 12 health club quality exercises within 300-400 square feet. Now, with over a dozen dual or multi-function stations, HOIST® can provide a state-of-the-art strength circuit for almost any center. The HD series offers an exciting blend of quality components, intuitive adjustments, superior biomechanics and excellent value.

## MODULAR MULTI-STATION

### HMG-4000 Series

The HOIST® Modular Multi-Station can be configured to meet both your space and fitness requirements. Customize a modular multi-station and choose from 13 different HS and HD exercise stations to create up to a 12 station or beyond. The strength and quality benefits of our HS and HD series is incorporated into the modular multi-station to assure ever-lasting performance.

### STANDARD FEATURES

- ◆ Ratcheting adjustment system provides quick and easy seat adjustments
- ◆ Easy Glide™ inserts on all telescoping pad adjustments
- ◆ Weight stack shields for added safety and privacy to the user
- ◆ Silent Steel® weight stacks are specifically designed for noise reduction during exercise
- ◆ 2" x 4" tubing provides a primary framework of unsurpassed strength and durability
- ◆ Commercial quality hand grips for added stability and comfort
- ◆ Removable non-skid rubber foot protector to guard facility flooring
- ◆ Refer to pages 22-23 for product specifications

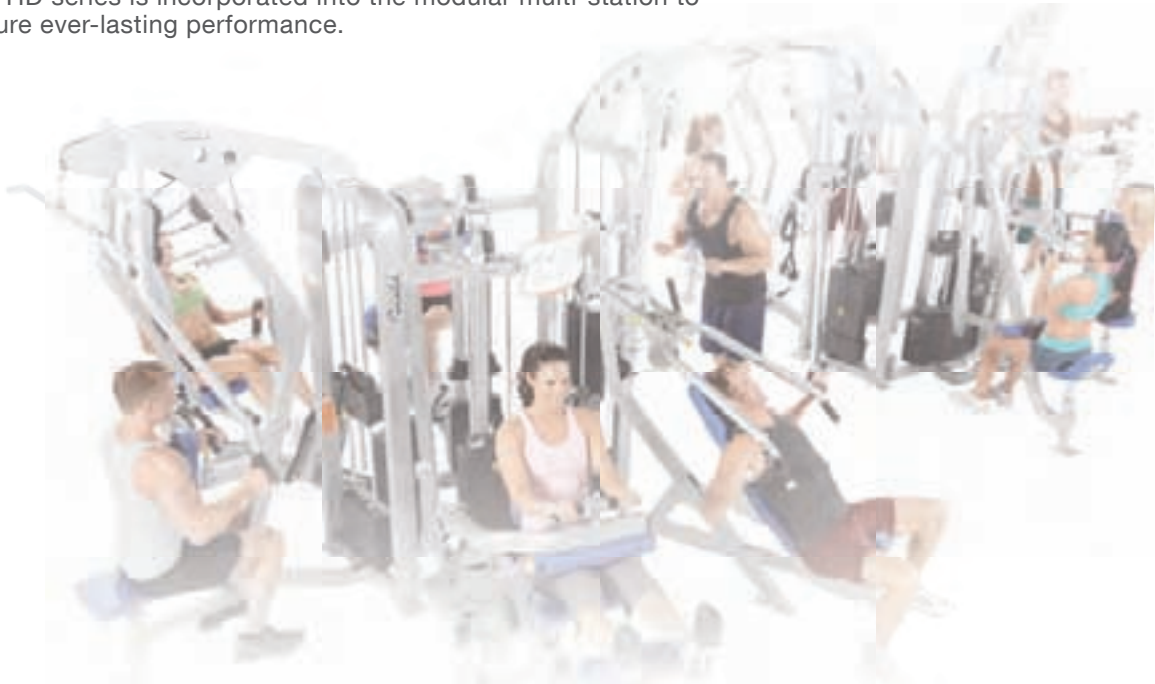



## MULTI-PRESS

HD/HDG-1500

- ◆ Multiple seat and press arm positions for vertical chest, incline and shoulder press exercises
- ◆ One handed rotational user support angle adjustment for quick back pad adjustments

Muscle Groups: Chest / Shoulders

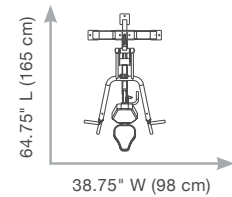

## PEC FLY / REAR DELT

HD/HDG-2200

- ◆ Adjustable range-of-motion exercise arm for pec fly or rear delt exercises
- ◆ Each exercise arm has dual pivots for user defined exercise path
- ◆ Swiveling handles with rotating grips provide multiple hand positions

Muscle Groups: Back / Chest / Shoulders

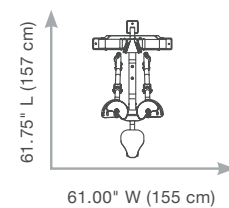

## MID ROW/LAT PULLDOWN

HD/HDG-2300

- ◆ Telescoping chest and back pad with integrated thigh hold-down provides proper positioning and support for pulldown and mid-row exercises
- ◆ Dual position hand grips for mid-row exercises
- ◆ Includes ultra-lite aluminum lat bar for lat pulldown exercises

Muscle Groups: Back / Shoulders

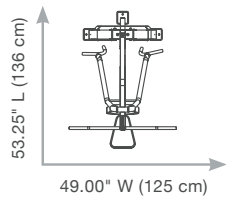

## LOW BACK

HS/HSG-1225

- ◆ Back pad rotates backwards simultaneously while the seat pad rotates in a forward arc to achieve optimal spinal extension
- ◆ Swivel back pad automatically adjusts to fit the user
- ◆ Angled foot supports with multiple horizontal adjustments
- ◆ Seat belt provides added stability during exercise

Muscle Groups: Back

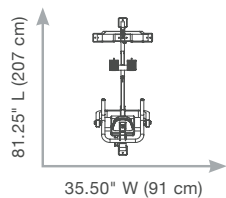



## MID ROW

HS/HSG-1725

- ◆ 3-D handles provide upward/downward, inward/outward and rotational movements
- ◆ Rotating hand grips automatically adjust, preventing wrist strain
- ◆ Swiveling chest pad self-aligns to user, reducing pressure on chest

Muscle Groups: Back

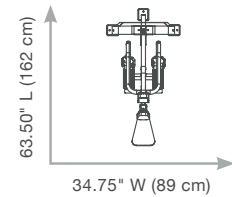

## LATERAL RAISE

HS/HSG-1525

- ◆ Exercise arms move independently
- ◆ Pivoting hand grips automatically adjust to varying arm lengths

Muscle Groups: Back / Shoulders

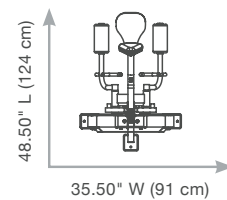

## AB CRUNCH

HS/HSG-1310

- ◆ Radial ball bearings for smooth pivot motion

Muscle Groups: Abdominals

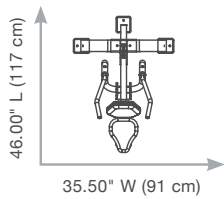

## ROTARY TORSO

HS/HSG-1350

- ◆ 180° Seat adjustment in 10° increments
- ◆ Angeled stationary torso stabilization pads and hand grips
- ◆ Adjustable seat rotation from the user position

Muscle Groups: Abdominals

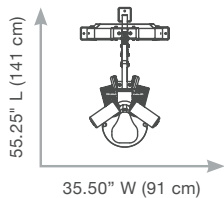



## STANDING BICEPS / TRICEPS

HD/HDG-1100

- ◆ Allows performance of biceps and triceps exercises in one machine
- ◆ Unique double swiveling handles follow the natural motion of the wrists during exercises
- ◆ Convenient bar storage rack for easy access

Muscle Groups: Arms

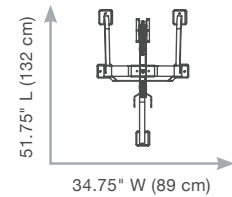

## KNEELING CHIN / DIP ASSISTS

HD/HDG-2100

- ◆ Easy-to-use kneeling exercise position
- ◆ User support pad can be locked at lowest position to perform non-assisted chin and dip exercises
- ◆ Dip handles rotate for wide or narrow grip positions
- ◆ Chin-up handles have wide and overhand positions

Muscle Groups: Arms / Back / Chest / Shoulders

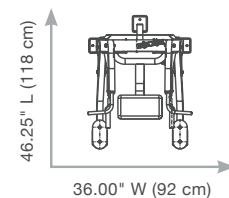

## LEG PRESS / CALF RAISE

HD/HDG-1610

- ◆ Eleven linear seat adjustments to accommodate varying leg lengths
- ◆ Large oval foot plate provides multiple foot placements for both leg press and calf exercises
- ◆ Integrated scuff guards are strategically placed to protect the machine's frame finish

Muscle Groups: Legs

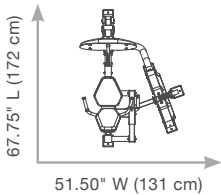

## INNER/OUTER THIGH

HD/HDG-1800

- ◆ Adjustable angle back pad to accommodate varying body sizes
- ◆ Thigh pads swivel for each exercise position
- ◆ Two foot support positions to provide lower body stability
- ◆ Exercise arms can be adjusted from the user position
- \* Sold Assembled

Muscle Groups: Legs

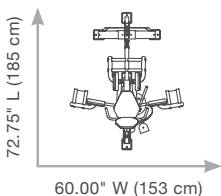





## LEG EXTENSION / SEATED LEG CURL

HD/HDG-2400

- ◆ Easy-to-use gas shock assisted adjustable back pad accommodates varying leg lengths
- ◆ Self-aligning roller pad automatically adjusts to reduce potential stress of the ankle joints
- ◆ Multiple range-of-motion adjustments for both exercises

Muscle Groups: Legs

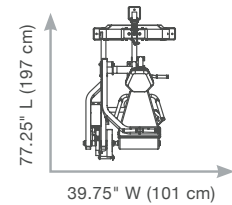

## MULTI-HIP

HD/HDG-2000

- ◆ Easy-to-use pivot point adjustments for proper exercise alignment
- ◆ Adjustable roller pad to accommodate varying leg lengths
- ◆ Exercise arm adjusts 360° for maximum positioning

Muscle Groups: Legs

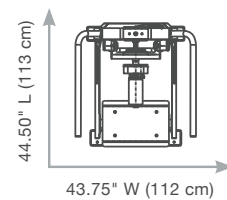

## 4-WAY NECK

HD/HDG-2500

- ◆ Double contoured head pad automatically adjusts to the user throughout the entire exercise range of motion
- ◆ Adjustable torso pad allows a choice between support (pad system assembled) and stability or increasing core strength (pad system removed)
- \* Sold / Ships Assembled

Muscle Groups: Neck

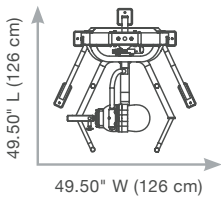

## WALL MOUNT MULTI-GYM

HD/HDG-500

- ◆ Space efficient wall mount design
- ◆ Ability for user to complete numerous upper and lower body exercises on one machine
- ◆ Integrated squat bar storage rack
- ◆ HF-169 removable bench provides adjustable flat, incline and decline bench exercises
- \* Sold / Ships Assembled

Muscle Groups: Chest / Legs / Shoulders

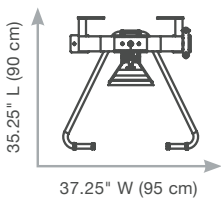

(Overhead view shown with HF-169 bench folded)



Example of HD/HDG-500 is easy to fold away to save floor space

## ADJUSTABLE HI/LO PULLEY

HS/HSG-1175

- ◆ 28 adjustable exercise positions in 2.5" increments
- ◆ Integrated adjuster system provides smooth and easy one-handed adjustments
- ◆ Pulley support shaft angles forward for exercise efficiency
- ◆ Stabilizing hand grips on both sides of pulley
- ◆ Includes strap handles (1 pair)
- ◆ Optional accessories: padded ankle / thigh strap and aluminum curl

Muscle Groups: Abdominals / Arms / Back / Chest / Legs / Shoulders

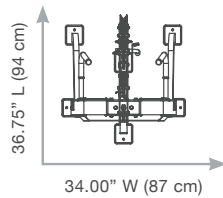

## CABLE CROSSOVER - TRADITIONAL

HD/HDG-1180

- ◆ Dual pull-up handles accommodates varying hand grip sizes
- ◆ Includes 2 Adjustable Hi/Lo Pulleys (HS-1175) and 1 Crossover Bar (HS-OPT-1)
- ◆ Includes strap handles (2 pairs)
- ◆ Optional accessories: padded ankle / thigh strap and aluminum curl

Muscle Groups: Abs / Arms / Back / Chest / Legs / Shoulders

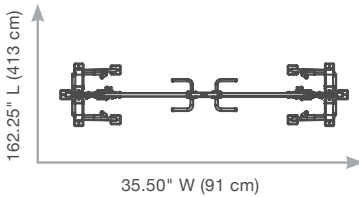

## CABLE CROSSOVER - SPACE SAVER

HD/HDG-1190

- ◆ Dual pull-up handles accommodates varying hand grip sizes
- ◆ Includes 2 Adjustable Hi/Lo Pulleys (HS-1175) and 1 Space Saver Crossover Bar (HS-OPT-2)
- ◆ Includes strap handles (2 pairs)
- ◆ Optional accessories: padded ankle / thigh strap and aluminum curl

Muscle Groups: Abs / Arms / Back / Chest / Legs / Shoulders

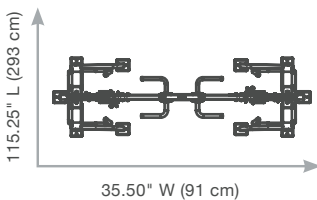



## PERSONAL PULLEY SYSTEM

HD/HDG-1910

- ◆ 28 adjustable exercise positions in 2.5" increments
- ◆ Integrated adjuster system provides smooth and easy one-handed adjustments
- ◆ Dual pulley support shafts angle forward for bilateral and unilateral exercises
- ◆ Integrated accessory rack for convenient storage of accessories
- ◆ Includes 2 Adjustable Hi/Lo Pulleys (HS-1175) and 1 Personal Pulley Connector (HS-OPT-03)
- ◆ Includes adjustable strap handles (1 pair), assist strap and padded ankle / thigh strap
- ◆ Optional accessories: aluminum curl bar (HD-OPT-02) and aluminum long bar (HD-OPT-03)

Muscle Groups: Abdominals / Arms / Back / Chest / Legs / Shoulders



## DUAL PULLEY SYSTEM

HD/HDG-1900, 1900-2

- ◆ 28 adjustable exercise positions in 2.5" increments
- ◆ Integrated adjuster system provides smooth and easy one-handed adjustments
- ◆ Dual pulleys for bilateral and unilateral exercises
- ◆ Instructional exercise placards illustrate proper use
- ◆ Dual graduated Silent Steel® weight stacks
  - ◆ HD-1900: 135 lbs. each (with 67.5 lbs. applied resistance)
  - ◆ HD-1900-2: 200 lbs. each (with 100 lbs. applied resistance)
- ◆ Integrated accessory rack for convenient storage of accessories
- ◆ Includes adjustable strap handles (1 pair), assist strap and padded ankle / thigh strap
- ◆ Optional accessories: aluminum curl bar (HD-OPT-02) and aluminum long bar (HD-OPT-03)

Muscle Groups: Abdominals / Arms / Back / Chest / Legs / Shoulders

## PRODUCT LOCATION

- Use our easy color coding system (shown below), the color shown next to the HMD or HMS exercise stations corresponds to the possible location on the main frame (also shown below).
- Refer to pages 14-17 to view examples of modular multi-station packages.



Example of a main frame to create a modular multi-station (HMG-4000)

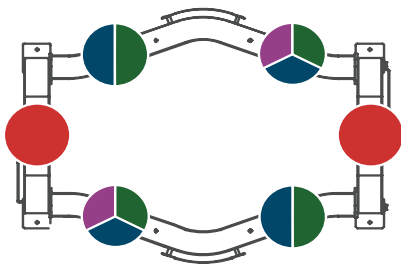

Easy Color Coding System

## MODULAR MULTI-STATION HMG-4000

The versatile modular multi-station can be customized to best fit your space and fitness requirements. Maximize the fitness possibilities and create a modular multi-station that offers a combination of single, dual or multi-function exercise stations.

### CHEST/SHOULDERS

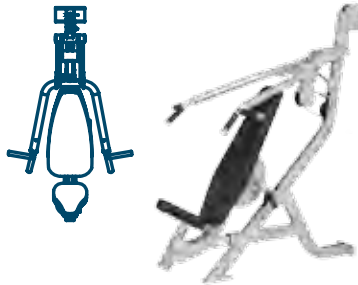

Chest Press HMD-1500

### SHOULDERS

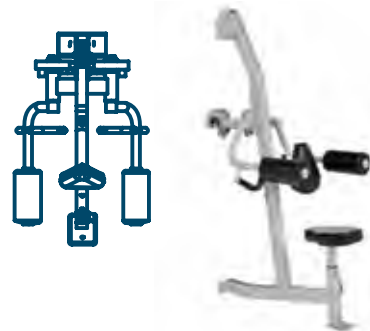

Lateral Raise HMS-1525

### FUNCTIONAL - MULTIPLE MUSCLE GROUPS

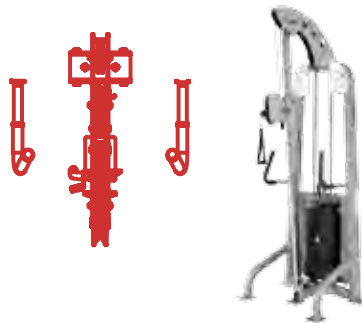

Adjustable Hi/Lo Pulley HMS-1175

### ARMS

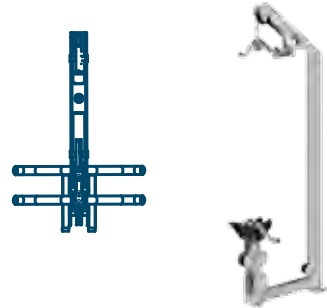

Standing Biceps/Triceps HMD-1100

### ABS

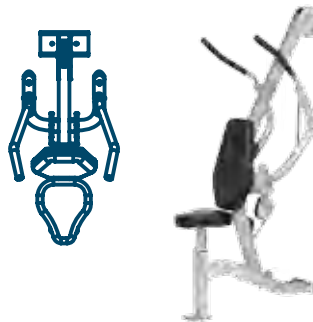

Ab Crunch HMS-1310

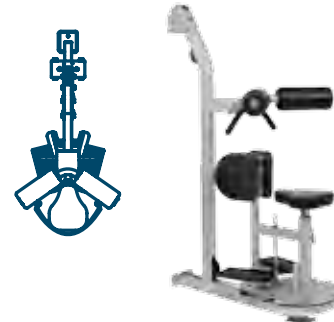

Rotary Torso HMS-1350

# **BUILD** A MODULAR MULTI-STATION AS A **3** STATION OR **EXPAND** TO A **12** STATION OR **BEYOND!**

## MODULAR MULTI-STATION STANDARD PRODUCT FEATURES

- ◆ Ratcheting adjustment system provides quick and easy seat adjustments
- ◆ Easy Glide™ inserts on all telescoping pad adjustments
- ◆ Weight stack shields for added safety and privacy to the user
- ◆ Silent Steel® weight stacks are specifically designed for noise reduction during exercise
- ◆ 2" x 4" tubing provides a primary framework of unsurpassed strength and durability
- ◆ Military Spec Cables - 4,200 lbs. Tension Strength
- ◆ Commercial quality hand grips for added stability and comfort
- ◆ Removable non-skid rubber foot protector to guard facility flooring

### BACK

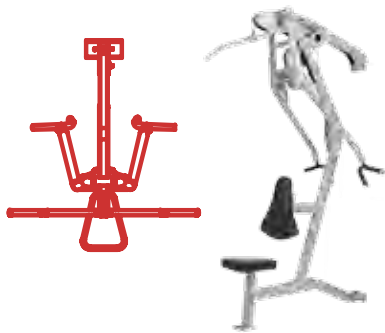

Mid Row/Lat Pulldown HMD-2300



Low Back HMD-1225

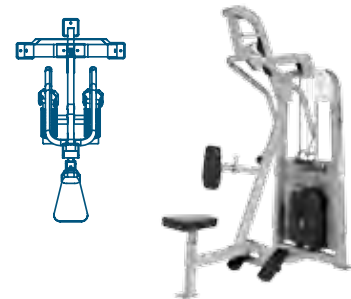

Mid Row HMS-1725

### LEGS

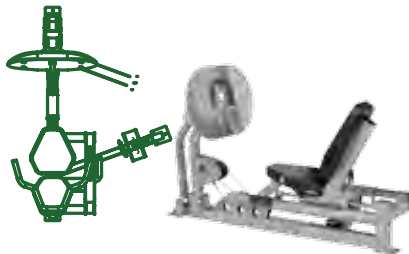

Leg Press/Calf Raise HMD-1610\*\*

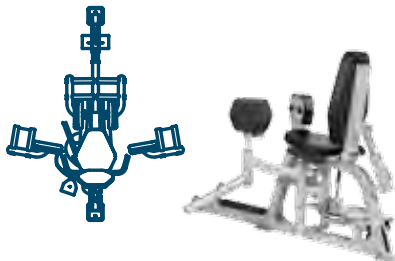

Inner/Outer Thigh HMD-1800\*

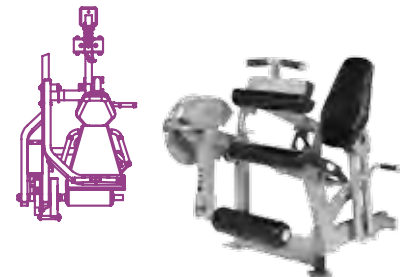

Leg Extension/Leg Curl HMD-2400

### 3 STATION

Sample package shown with HMG-4000, HMS-1175, HMD-1610, HMD-2300

#### SPECIFICATIONS:

US / METRIC

131.25" L x 76.25" W x 91.25" H  
(334 cm x 194 cm x 232 cm)

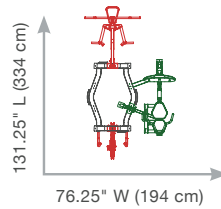

### 4 STATION

Sample package shown with HMG-4000, HMS-1175, HMD-2400, HMD-1500, HMD-2300

#### SPECIFICATIONS:

US / METRIC

131.25" L x 94.75" W x 91.25" H  
(334 cm x 241 cm x 232 cm)

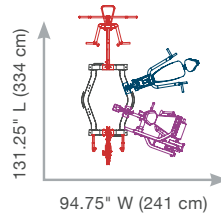

### 5 STATION

Sample package shown with HMG-4000, HMS-1175, HMD-2400, HMD-1500, HMD-2300, HMD-1610

#### SPECIFICATIONS:

US / METRIC

131.25" L x 128.00" W x 91.25" H  
(334 cm x 326 cm x 232 cm)

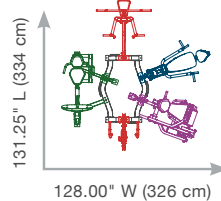

### 6 STATION

Sample package shown with HMG-4000, HMS-1175, HMS-1525, HMS-1225, HMD-2300, HMD-2400, HMD-1500

#### SPECIFICATIONS:

US / METRIC

131.25" L x 153.75" W x 91.25" H  
(334 cm x 391 cm x 232 cm)

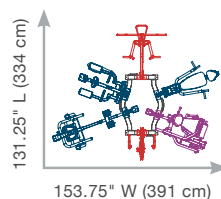



## 7 STATION

Sample package shown with HMG-4000, HMS-1175, HS-OPT-01 or HS-OPT-2 (as shown), HMS-1350, HMD-1500, HMD-2400, HMD-2300, HMS-1225, HS-1175

7 Station with Cable Crossover - Traditional

### SPECIFICATIONS:

US / METRIC

249.00" L x 153.75" W x 91.25" H  
(633 cm x 391 cm x 232 cm)

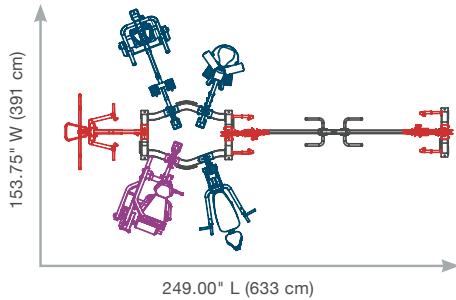

7 Station with Cable Crossover - Space Saver

### SPECIFICATIONS:

US / METRIC

211.00" L x 153.75" W x 91.25" H  
(536 cm x 391 cm x 232 cm)

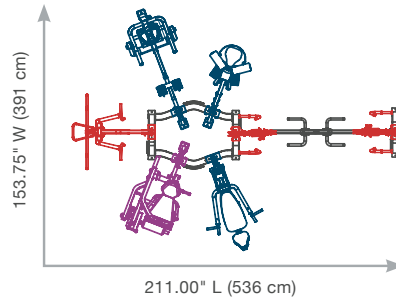

### EXPAND YOUR MULTI-STATION

- ◆ Add a traditional or space-saver crossover bar between 2 Adjustable Hi/Lo Pulleys (HMS-1175) on each main frame.
- ◆ 2 Adjustable Hi/Lo Pulleys (HS-1175 or HMS-1175) must be purchased to create a 7-station or larger.

Cable Crossover - Traditional (HS-OPT-01)

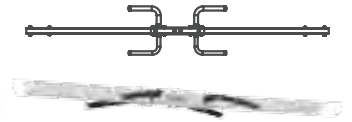

Cable Crossover - Space Saver (HS-OPT-02)

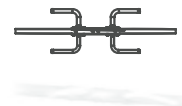

## 12 STATION

Sample package shown with (2) HMG-4000, (3) HMS-1175, HS-OPT-01 OR HS-OPT-02 (as shown), HMD-1100, HMS-1725, HMS-1350, HMS-1225, HMD-2300, HMD-2400, HMD-1500, HMD-1700, HMS-1525



12 Station with Cable Crossover - Traditional

### SPECIFICATIONS:

US / METRIC

347.25" L x 161.00" W x 91.25" H  
(883 cm x 409 cm x 245 cm)

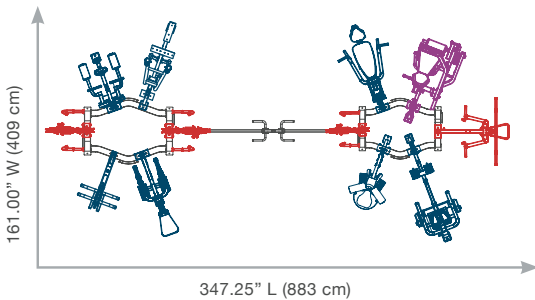

12 Station with Cable Crossover - Space Saver

**SPECIFICATIONS:**

US / METRIC

319.25" L x 161.00" W x 91.25" H  
(811 cm x 409 cm x 245 cm)

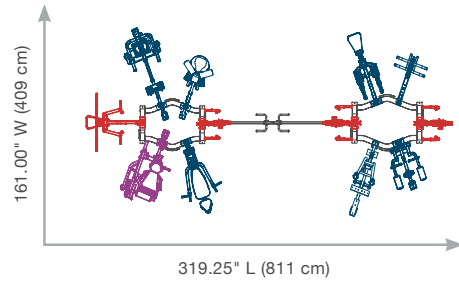

## SINGLE/DUAL/FUNCTIONAL PRODUCT SPECIFICATIONS

Product Name		Product Dimensions L x W x H	Product Weight	Weight Stack	Weight Stack Configuration			
<b>Wall Mount Multi-Gym HDG-500</b> (with HF-169 Bench)	Standard	71.50" x 37.25" x 78.00"	750 lbs.	299 lbs.	1 x 49 lbs.		2 - 21 x 12.5 lbs.	
	Metric	182 cm x 95 cm x 199 cm	341 kg	136 kg	1 x 23 kg		2 - 21 x 6 kg	
<b>Wall Mount Multi-Gym HDG-500</b> (without HF-169 Bench)	Standard	35.25" x 37.25" x 78.00"	669 lbs.	299 lbs.	1 x 49 lbs.		2 - 21 x 12.5 lbs.	
	Metric	90 cm x 95 cm x 199 cm	304 kg	136 kg	1 x 23 kg		2 - 21 x 6 kg	
<b>Standing Biceps / Triceps HD-1100</b>	Standard	51.75" x 34.75" x 74.25"	501 lbs.	241 lbs.	1 x 13 lbs.	2 - 6 x 8 lbs.	7 - 21 x 12.5 lbs.	
	Metric	132 cm x 89 cm x 189 cm	228 kg	110 kg	1 x 6 kg	2 - 6 x 4 kg	7 - 21 x 6 kg	
<b>Standing Biceps / Triceps HDG-1100</b>	Standard	51.75" x 34.75" x 74.25"	561 lbs.	301 lbs.	1 x 13 lbs.	2 - 16 x 12.5 lbs.	7 - 21 x 20 lbs.	
	Metric	132 cm x 89 cm x 189 cm	255 kg	137 kg	1 x 6 kg	2 - 6 x 6 kg	7 - 21 x 10 kg	
<b>Cable Crossover (Traditional) HD-1180</b>	Standard	162.25" x 35.50" x 92.00"	980 lbs.	2 (203 lbs.)	2 (1 x 13 lbs.)	2 (2 - 16 x 8.5 lbs.)	2 (17 - 21 x 12.5 lbs.)	
	Metric	413 cm x 91 cm x 234 cm	445 kg	2 (93 kg)	2 (1 x 6 kg)	2 (2 - 16 x 4 kg)	2 (17 - 21 x 5.75 kg)	
<b>Cable Crossover (Traditional) HDG-1180</b>	Standard	162.25" x 35.50" x 92.00"	1,068 lbs.	2 (244 lbs.)	2 (1 x 13 lbs.)	2 (2 - 16 x 8.5 lbs.)	2 (17 - 21 x 12.5 lbs.)	
	Metric	413 cm x 91 cm x 234 cm	485 kg	2 (111 kg)	2 (1 x 6 kg)	2 (2 - 16 x 4 kg)	2 (17 - 21 x 5.75 kg)	
<b>Cable Crossover (Space-Saver) HD-1190</b>	Standard	115.25" x 35.50" x 92.00"	934 lbs.	2 (203 lbs.)	2 (1 x 13 lbs.)	2 (2 - 16 x 8.5 lbs.)	2 (17 - 21 x 12.5 lbs.)	
	Metric	293 cm x 91 cm x 234 cm	424 kg	2 (93 kg)	2 (1 x 6 kg)	2 (2 - 16 x 4 kg)	2 (17 - 21 x 5.75 kg)	
<b>Cable Crossover (Space-Saver) HDG-1190</b>	Standard	115.25" x 35.50" x 92.00"	1,022 lbs.	2 (244 lbs.)	2 (1 x 13 lbs.)	2 (2 - 16 x 8.5 lbs.)	2 (17 - 21 x 12.5 lbs.)	
	Metric	293 cm x 91 cm x 234 cm	464 kg	2 (111 kg)	2 (1 x 6 kg)	2 (2 - 16 x 4 kg)	2 (17 - 21 x 5.75 kg)	
<b>Multi-Press HD/HDG-1500</b>	Standard	64.75" x 38.75" x 68.75"	578 lbs.	263 lbs.	1 x 49 lbs.		2 - 21 x 12.5 lbs.	
	Metric	165 cm x 98 cm x 174 cm	263 kg	120 kg	1 x 23 kg		2 - 21 x 6 kg	
<b>Leg Press / Calf Raise HD/HDG-1610</b>	Standard	67.75" x 51.50" x 69.00"	868 lbs.	445 lbs.	1 x 13 lbs.		2 - 21 x 20 lbs.	
	Metric	172 cm x 131 cm x 176 cm	394 kg	202 kg	1 x 6 kg		2 - 21 x 10 kg	
<b>Lat Pulldown / High Row HD/HDG-1700</b>	Standard	62.50" x 35.50" x 96.00"	635 lbs.	275 lbs.	1 x 12 lbs.	2 - 6 x 12.5 lbs.	7 - 16 x 20 lbs.	
	Metric	159 cm x 91 cm x 244 cm	289 kg	125 kg	1 x 6 kg	2 - 6 x 6 kg	7 - 16 x 10 kg	
<b>Inner / Outer Thigh HD/HDG-1800</b>	Standard	72.75" x 60.00" x 69.00"	581 lbs.	200 lbs.	1 x 12 lbs.		2 - 16 x 12.5 lbs.	
	Metric	185 cm x 153 cm x 176 cm	264 kg	91 kg	1 x 6 kg		2 - 16 x 6 kg	
<b>Dual Pulley HD/HDG-1900</b>	Standard	43.75" x 77.50" x 92.50"	670 lbs.	2 (135 lbs.)	2 (1 x 13 lbs.)	2 (2-6x4 lbs.)	2 (7-11x8 lbs.)	2 (12-16x12.5 lbs.)
	Metric	112 cm x 197 cm x 235 cm	304 kg	2 (62 kg)	2 (1 x 6 kg)	2 (2-6x2 kg)	2 (7-11x4 kg)	2 (12-16x6 kg)
<b>Dual Pulley HD/HDG-1900-2</b>	Standard	43.75" x 77.50" x 92.50"	800 lbs.	2 (200 lbs.)	2 (1 x 13 lbs.)	2 (2-6x4 lbs.)	2 (7-11x8 lbs.)	2 (12-16x12.5 lbs.)
	Metric	112 cm x 197 cm x 235 cm	363 kg	2 (91 kg)	2 (1 x 6 kg)	2 (2-6x2 kg)	2 (7-11x5 kg)	2 (12-16x6 kg)
<b>Personal Pulley System HD-1910</b>	Standard	42.00" x 99.50" x 91.25"	949 lbs.	2 (203 lbs.)	2 (1 x 13 lbs.)	2 (2 - 16 x 8.5 lbs.)	2 (17 - 21 x 12.5 lbs.)	
	Metric	107 cm x 253 cm x 232 cm	431 kg	2 (93 kg)	2 (1 x 6 kg)	2 (2 - 16 x 4 kg)	2 (17 - 21 x 6 kg)	

## SINGLE/DUAL/FUNCTIONAL PRODUCT SPECIFICATIONS

Product Name		Product Dimensions L x W x H	Product Weight	Weight Stack	Weight Stack Configuration		
Personal Pulley System HDG-1910	Standard	42.00" x 99.50" x 91.25"	1,037 lbs.	2 (244 lbs.)	2 (244 lbs.)	2 (1 x 13 lbs)	2 (17 - 21 x 12.5 lbs)
	Metric	107 cm x 253 cm x 232 cm	471 kg	2 (111 kg)	2 (111 kg)	2 (1 x 6 kg)	2 (17 - 21 x 6 kg)
Multi-Hip HD/HDG-2000	Standard	44.50" x 43.75" x 63.75"	783 lbs.	276 lbs.	276 lbs.	1 x 13 lbs	7 - 16 x 20 lbs
	Metric	113 cm x 112 cm x 162 cm	356 kg	126 kg	126 kg	1 x 6 kg	7 - 16 x 10 kg
Kneeling Chin / Dip Assist HD/HDG-2100	Standard	46.25" x 36.00" x 84.50"	532 lbs.	217 lbs.	1 x 29 lbs		2 - 16 x 12.5 lbs
	Metric	118 cm x 92 cm x 215 cm	242 kg	99 kg	1 x 14 kg		2 - 16 x 6 kg
Pec Fly / Rear Delt HD/HDG-2200	Standard	61.75" x 61.00" x 78.75"	576 lbs.	263 lbs.	1 x 13 lbs.		2 - 21 x 12.5 lbs.
	Metric	157 cm x 155 cm x 201 cm	262 kg	120 kg	1 x 6 kg		2 - 21 x 6 kg
Mid Row / Lat Pulldown HD/HDG-2300	Standard	53.25" x 49.00" x 89.25"	534 lbs.	200 lbs.	1 x 12 lbs.		2 - 16 x 12.5 lbs.
	Metric	136 cm x 125 cm x 227 cm	243 kg	91 kg	1 x 6 kg		2 - 16 x 6 kg
Leg Ext./ Seated Leg Curl HD/HDG-2400	Standard	77.25" x 39.75" x 69.00"	735 lbs.	263 lbs.	1 x 12 lbs.		2 - 16 x 12.5 lbs.
	Metric	197 cm x 101 cm x 176 cm	334 kg	120 kg	1 x 6 kg		2 - 16 x 6 kg
4-Way Neck HD/HDG-2500	Standard	49.50" x 49.50" x 64.25"	424 lbs.	178 lbs.	1 x 12 lbs.	2 - 6 x 8 lbs.	7 - 16 x 12.5 lbs.
	Metric	126 cm x 126 cm x 164 cm	193 kg	81 kg	1 x 6 kg	2 - 6 x 4 kg	7 - 16 x 6 kg
Adjustable Hi-Lo Pulley HS-1175	Standard	36.75" x 34.00" x 91.25"	457 lbs.	203 lbs.	1 x 13 lbs.	2 - 16 x 8.5 lbs.	7 - 16 x 12.5 lbs.
	Metric	94 cm x 87 cm x 232 cm	208 kg	93 kg	1 x 6 kg	2 - 16 x 4 kg	7 - 16 x 6 kg
Adjustable Hi-Lo Pulley HSG-1175	Standard	36.75" x 34.00" x 91.25"	501 lbs.	244 lbs.	1 x 13 lbs.	2 - 16 x 8.5 lbs.	7 - 16 x 12.5 lbs.
	Metric	94 cm x 87 cm x 232 cm	228 kg	111 kg	1 x 6 kg	2 - 16 x 4 kg	7 - 16 x 6 kg
Low Back HS/HSG-1225	Standard	81.25" x 35.50" x 68.75"	529 lbs.	200 lbs.	1 x 12 lbs.		2 - 16 x 12.5 lbs.
	Metric	207 cm x 91 cm x 175 cm	240 kg	91 kg	1 x 6 kg		2 - 16 x 6 kg
Ab Crunch HS/HSG-1310	Standard	46.00" x 35.50" x 68.75"	402 lbs.	178 lbs.	1 x 13 lbs.	2 - 16 x 8 lbs.	7 - 16 x 12.5 lbs.
	Metric	117 cm x 91 cm x 175 cm	183 kg	81 kg	1 x 6 kg	2 - 16 x 4 kg	7 - 16 x 6 kg
Rotary Torso HS/HSG-1350	Standard	55.25" x 35.50" x 68.75"	524 lbs.	178 lbs.	1 x 12 lbs.	2 - 6 x 8 lbs.	7 - 16 x 12.5 lbs.
	Metric	141 cm x 91 cm x 175 cm	238 kg	81 kg	1 x 6 kg	2 - 6 x 4 kg	7 - 16 x 6 kg
Lateral Raise HS/HSG-1525	Standard	48.50" x 35.50" x 68.75"	453 lbs.	200 lbs.	1 x 12 lbs.		2 - 16 x 12.5 lbs.
	Metric	124 cm x 91 cm x 175 cm	206 kg	91 kg	1 x 6 kg		2 - 16 x 6 kg
Mid Row HS/HSG-1725	Standard	63.50" x 34.75" x 79.50"	465 lbs.	200 lbs.	1 x 12 lbs.		2 - 16 x 12.5 lbs.
	Metric	162 cm x 89 cm x 202 cm	211 kg	91 kg	1 x 6 kg		2 - 16 x 6 kg
Traditional Crossover Bar HS-OPT-01	Standard	94.00" x 18.00" x 5.00"	67 lbs.	N/A	N/A		N/A
	Metric	239 cm x 46 cm x 13 cm	31 kg	N/A	N/A		N/A
Space Saver Crossover Bar HS-OPT-02	Standard	66.00" x 18.00" x 5.00"	45 lbs.	N/A	N/A		N/A
	Metric	168 cm x 46 cm x 13	21 kg	N/A	N/A		N/A

## OPTIONAL HOIST® PRODUCTS

HOIST® CF and ROC-IT™ products are built with superb components and unique space saving designs that will compliment all HD, HS or HMG products. For more information, please contact a HOIST® Sales Representative at 800.548.LIFT (5438) or sales@hoistfitness.com.



**DUMBBELL RACKS**  
3-Tier Dumbbell Rack  
CF-3461-3



**BENCHES**  
Olympic Incline Bench  
CF-3172



**ROC-IT™ SELECTORIZED**  
Leg Press  
RS-1403



**ROC-IT™ PLATE LOADED**  
Abs  
RPL-5601

## STANDARD FRAME COLORS

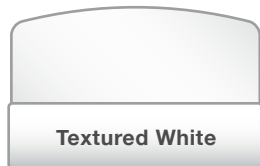

Textured White

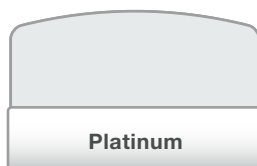

Platinum

## STANDARD UPHOLSTERY COLOR

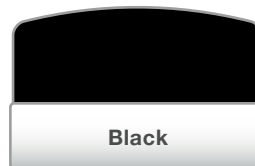

Black

Custom upholstery colors are available for an additional charge. For more information, please contact a HOIST® Sales Representative at 800.548.LIFT (5438) or sales@hoistfitness.com.

NOTE: Actual frame and upholstery colors may differ from printed color samples shown.

## HOIST® WARRANTY POLICY

HOIST® offers the best warranty policy in the industry, reaffirming our commitment to quality and customer satisfaction. HOIST® warranties this product to the original purchaser only. HOIST® guarantees this product to be free from defects in workmanship and/or materials under normal use or service. If at any time a component is defective, HOIST® will repair it free of cost! For more information about the HOIST® Warranty policy, please refer to www.hoistfitness.com.



### LIFETIME FRAME:

Warranty for the lifetime of the product and applies to defects from the manufacturer only.

### 5 YEARS MOVING PARTS:

Applies to defects from the manufacturer only.

### 1 YEAR PAINT, CABLES & UPHOLSTERY:

Applies to defects from the manufacturer only.

HOIST® reserves the right to change product specifications, design, and function at any time.

## TRADEMARKS AND PATENTS

All HOIST® products are covered by U.S. Patents, Patents Pending and Trademarks. HOIST® is a registered trademark. All Rights Reserved. †

- HOIST®
- RADIAL LOC®
- SILENT STEEL®
- QUIK-CHANGE®
- GLUTEMASTER®
- FEEL THE RIDE®
- CLUB QUALITY GUARANTEED®
- ULTRA-LITE LIFTING SYSTEM™
- ROC®
- ROX™
- ROC-IT™
- ROC-ABS™
- EASY GLIDE™
- COMPOSITE MOTION™
- DUAL ACTION SMITH®
- SPLIT WEIGHT CABLING™
- EZ-LOC LATCHING MECHANISM™
- RIDE ORIENTED XERCISE®
- RIDE ORIENTED CIRCUIT-INTERVAL TRAINING™
- RIDE ORIENTED CONDITIONING-INTENSITY TRAINING™
- CABLE-DRIVEN™

D370,950, D427,652, D431,059, D431,615, D437,370, D437,371, D438,267, D439,292, D439,822, D439,943, D440,610, D444,190, D444,518, D446,440, D446,831, D454,604, D455,184, D455,310, D455,803, D456,862, D457,580, D519,585, D541,357, D541,358, D541,893, D542,868, D544,050, D556,842, D574,448, D574, 449, D577,234, D583,426, D590,032, 4,949,951, 5,236,406, 5,401,227, 5,681,247, 5,683,334, 5,733,233, 5,800,321, 5,807,219, 5,916,072, 5,938,574, 5,951,444, 5,961,428, 5,980,434, 6,004,247, 6,030,322, 6,039,678, 6,090,020, 6,102,835, 6,193,635, 6,264,586, 6,264,588, 6,287,241, 6,319,178, 6,338,701, 6,347,777, 6,409,637, 6,443,878, 6,491,609, 6,497,639, 6,551,226, 6,561,960, 6,579,213, 6,605,022, 6,645,130, 6,988,977, 7,052,444, 7,166,066, 7,316,634, 7,322,906, 7,322,911, 7,331,911, 7,335,140, 7,335,145, 7,361,125, 7,384,381, 7,393,309, 7,468,024, 7,544,156, 7,549,949, 7,563,209, 7,563,214, 7,594,880, 7,597,655, 7,601,187, 7,654,938, 7,654,940, 7,670,269, 7,713,179, 7,717,832, 7,731,638, 7,749,143 † Other Patents Pending



\* Registered trademarks of HOIST® Fitness Systems

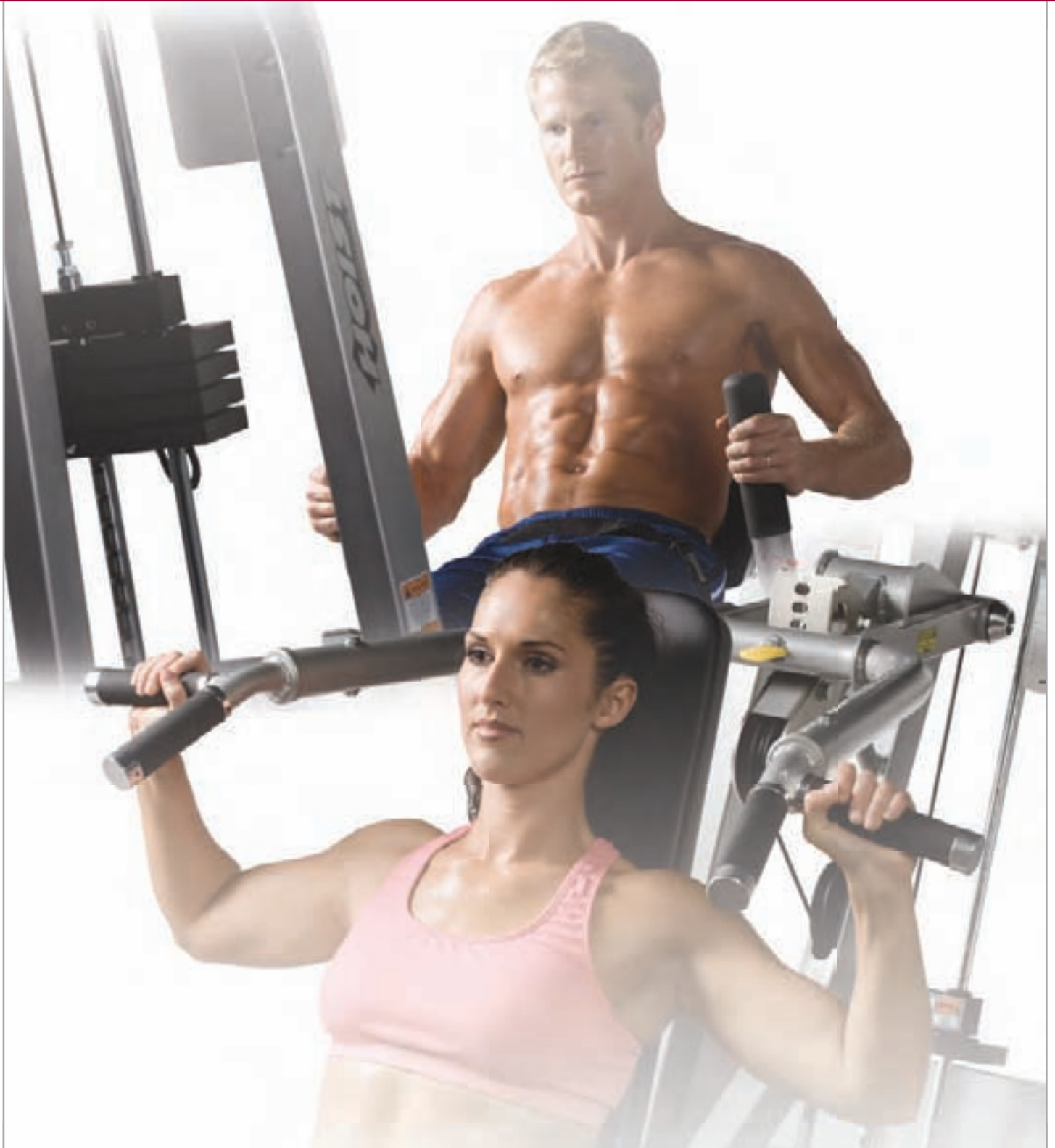



9990 empire street  
san diego, ca 92126  
800.548.LIFT (5438)  
sales@hoistfitness.com

© February 2008 HOIST® Fitness Systems. All Rights Reserved. www.hoistfitness.com (0208A)



GSA Contract # GS-07F-0322K  
Gene Bruton 866.488.6853